



## PRODUCT INSTRUCTIONS

### D2 SERIES ENCLOSURES

Available with  
**MVP**  
MULTI VOLT PLATFORM





# Table of Contents

<b>Limited Warranty Info</b> .....	<b>0</b>
<b>Product Installation Precautions, Warnings, and Installation Guidelines</b> .....	<b>1</b>
<b>D2 Component Checklist for camera installation / Camera Mount Bracket</b> .....	<b>2</b>
<b>Intro to MVP Power</b> .....	<b>3</b>
<b>24V Input MVP Power</b> .....	<b>4</b>
<b>High Voltage Input MVP Power</b> .....	<b>5</b>
<b>Camera Power Setup</b> (Standard 12VDC Connector and NON-STANDARD 12VDC CONNECTOR) .....	<b>6</b>
<b>Camera Installation</b> (Generic) .....	<b>7</b>
<b>Camera Height Adjustment</b> .....	<b>8</b>
<b>Camera Bracket Installation</b> .....	<b>9-22</b>
Axis 213 PTZ / Canon V6-C50iR .....	<b>9</b>
Axis 214 PTZ .....	<b>10</b>
Axis 231D & 232D.....	<b>11</b>
Axis 233D PTZ .....	<b>12, 13</b>
Canon VB-C300 .....	<b>14</b>
Panasonic NS-202 .....	<b>15</b>
Panasonic BB-HCM 381 / 580 / 581 & KX-HM C280.....	<b>16</b>
Sony RZ25N .....	<b>17</b>
Sony RZ30N .....	<b>18</b>
Sony RZ50N .....	<b>19</b>
Sony RX550N .....	<b>20</b>
Toshiba WB21A .....	<b>21, 22</b>
<b>COOLDOME Input Configuration</b> .....	<b>23, 24</b>
<b>Steady Step Mounting Instructions</b> .....	<b>25</b>
<b>Conduit Guidelines</b> .....	<b>26</b>
<b>Vent Plugs Installation Guide</b> .....	<b>27</b>
<b>D2 Exploded View</b> .....	<b>28</b>
<b>D2 Mounting Template</b> .....	<b>29</b>



# LIMITED WARRANTY

## DOTWORKZ, INC. PRODUCTS

**DOTWORKZ SYSTEMS INC.** Warrants this Product to be free from defects in material or workmanship, as follows:

PRODUCT CATEGORY	PARTS	LABOR
All Enclosures and Electronics	One (1) Year	One (1) Year
Power Supplies	One (1) Year	One (1) Year
Accessory Brackets	One (1) Year	One (1) Year

During the warranty period, to repair the Product the Purchaser will deliver it to Dotworkz Systems Inc. San Diego, CA, or return the defective product, freight prepaid. The Product to be repaired is to be returned in either its original carton or a similar package presenting an equal degree of protection with a Return Materials Authorization number displayed on the outer box or packing slip. To obtain RMA # you must contact our Technical Support Team at **866-575-4689**. Dotworkz Systems will return the repaired Product, freight paid. Dotworkz Systems is not obligated to provide Purchaser with a substitute unit during the warranty period or at any time. After the applicable warranty period, Purchaser must pay all labor and/or parts and shipping charges.

The limited warranty stated in these product instructions is subject to all of the following terms and conditions:

- 1. NOTIFICATION OF CLAIMS: WARRANTY SERVICE:** If Purchaser believes that the Product is defective in material or workmanship, then a written notice with an explanation of the claim shall be given promptly by Purchaser to Dotworkz Systems but all claims for warranty service must be made within the warranty period. If after investigation Dotworkz Systems determines that the reported problem was not covered by the warranty, Purchaser shall pay Dotworkz Systems for the cost of investigating the problem at its then prevailing per incident billable rate. No repair or replacement of any Product or part thereof shall extend the warranty period as to the entire Product. The specific warranty on the repaired part only shall be in effect for a period of ninety (90) days following the repair or replacement of that part or the remaining period of the Product parts warranty, whichever is greater
- 2. EXCLUSIVE REMEDY: ACCEPTANCE:** Purchaser's exclusive remedy and Dotworkz System's sole obligation is to supply (or pay for) all labor necessary to repair any Product found to be defective within the warranty period and to supply, at no extra charge, new or rebuilt replacements for defective parts
- 3. EXCEPTIONS TO LIMITED WARRANTY:** Dotworkz Systems shall have no liability or obligation to Purchaser with respect to any Product requiring service during the warranty period which is subjected to any of the following: abuse, improper use, negligence, accidents, lightning damage or other acts of God (i.e., hurricanes, earthquakes), modification, failure of the end-user to follow the directions outlined in the product instructions, failure of the end-user to follow the maintenance procedures written and recommended in the product instructions and service manual, or recommended by the International Security Industry Organization. Furthermore, Dotworkz Systems shall have no liability where a schedule is specified for regular replacement, maintenance or cleaning of certain parts (based on usage) that the end-user has failed to abide to such schedule; attempted repair by non-qualified personnel; operation of the Product outside of the published environmental and electrical parameters; if such Product's original identification (trademark, serial number) markings have been defaced, altered, or removed. Dotworkz Systems excludes from warranty coverage Products sold AS IS and/or WITH ALL FAULTS and excludes used Products which have not been sold by Dotworkz Systems to the Purchaser. All software and accompanying documentation furnished with, or as part of the Product is furnished "AS IS" (i.e., without any warranty of any kind), except where expressly provided otherwise in any documentation or license agreement furnished with the Product.
- 4. PROOF OF PURCHASE:** The purchaser's dated bill of sale must be retained as evidence of the date of purchase and to establish warranty eligibility.



**DISCLAIMER OF WARRANTY** EXCEPT FOR THE FOREGOING WARRANTIES, DOTWORKZ SYSTEMS HEREBY DISCLAIMS AND EXCLUDES ALL OTHER WARRANTIES, EXPRESSED OR IMPLIED, INCLUDING, BUT NOT LIMITED TO ANY AND/OR ALL IMPLIED WARRANTIES OF MERCHANTABILITY, FITNESS FOR A PARTICULAR PURPOSE AND/OR ANY WARRANTY WITH REGARD TO ANY CLAIM OF INFRINGEMENT THAT MAY BE PROVIDED IN SECTION 2-312(3) OF THE UNIFORM COMMERCIAL CODE AND/OR IN ANY OTHER COMPARABLE STATE STATUTE. DOTWORKZ SYSTEMS HEREBY DISCLAIMS ANY REPRESENTATIONS OR WARRANTY THAT THE PRODUCT IS COMPATIBLE WITH ANY COMBINATION OF NON-VIDEOLARM PRODUCTS OR NON-DOTWORKZ SYSTEMS RECOMMENDED PRODUCTS THAT THE PURCHASER CHOOSES TO CONNECT TO THE PRODUCT.

**LIMITATION OF LIABILITY** THE LIABILITY OF DOTWORKZ SYSTEMS, IF ANY, AND PURCHASER'S SOLE AND EXCLUSIVE REMEDY FOR DAMAGES FOR ANY CLAIM OF ANY KIND WHATSOEVER, REGARDLESS OF THE LEGAL THEORY AND WHETHER ARISING IN TORT OR CONTRACT SHALL NOT BE GREATER THAN THE ACTUAL PURCHASE PRICE OF THE PRODUCT WITH RESPECT TO WHICH SUCH CLAIM IS MADE. IN NO EVENT SHALL DOTWORKZ SYSTEMS BE LIABLE TO PURCHASER FOR ANY SPECIAL, INDIRECT, INCIDENTAL, OR CONSEQUENTIAL DAMAGES OF ANY KIND INCLUDING BUT NOT LIMITED TO COMPENSATION, REIMBURSEMENT OR DAMAGES ON ACCOUNT OF THE LOSS OF PRESENT OR PROSPECTIVE PROFITS, OR FOR ANY OTHER REASON WHATSOEVER.

## PRODUCT INSTALLATION PRECAUTIONS – WARNINGS – ADDITIONAL INFORMATION (RETAIN THIS DOCUMENT)

### IMPORTANT SAFEGUARDS

- 1 **Read Instructions** - All the safety and operating instructions should be read before the unit is operated.
- 2 **Retain Instructions** -The safety and operating instructions should be retained for future reference.
3. **Heed Warnings** - All warnings on the unit and in the operating instructions should be adhered to.
4. **Follow Instructions** -All operating & user instructions should be followed.
5. **Electrical Connections** - Only a qualified electrician should make electrical connections.
6. **Attachments** - Do not use attachments not recommended by the product manufacturer as they may cause hazards
7. **Cable Runs** - All cable runs must be within permissible distance
8. **Mounting** -This unit must be properly and securely mounted to a supporting structure capable of sustaining the weight of the unit. Accordingly:
  - a. Installation should be made by a qualified installer.
  - b. Installation should be in compliance with local codes
  - c. Care should be exercised to select suitable hardware to install the unit, taking into account both the composition of the mounting surface and the weight of the unit. Be sure to periodically examine the unit and the supporting structure to make sure that the integrity of the installation is intact. Failure to comply with the foregoing could result in the unit separating from the support structure and falling, with resultant damages or injury to anyone or anything struck by the falling unit,

CAUTION: TO REDUCE THE RISK OF ELECTRICAL SHOCK, DO NOT EXPOSE COMPONENTS TO WATER OR MOISTURE	
	The lightning flash with an arrowhead symbol, within an equilateral triangle, is intended to alert the user to the presence of non-insulated "dangerous voltage" within the product's enclosure that may be of sufficient magnitude to constitute a risk of electric shock to persons
	The exclamation point within an equilateral triangle is intended to alert the user to the presence of important operating and maintenance (servicing) instructions in the literature accompanying the appliance

### SERVICE

If the unit ever needs repair service, customer should contact Dotworkz Systems +1 (619) 224-LIVE (5483) for return authorization & shipping instructions

### UNPACKING

Unpack carefully. Electronic components can be damaged if improperly handled or dropped. If an item appears to have been damaged in shipment, replace it properly in its carton and notify the shipper. **Be sure to save**

1. The shipping carton and packaging material. They are the safest material in which to make future shipments of the equipment.
2. These Installation and Operating Instructions.

- ✓ For technical questions or product returns – call Dotworkz Customer Service (866-575-4689) 7:30 AM to 4:30 PM (PST). The proper technician will contact you as soon as possible.
- The External Nut on All electrical wire feed Glands must be tightened to create a weather tight seal prior to putting D2 in service. Failure to create this seal may result in water incursion into enclosure. This may lead to electrical shock, product failure and damage to electrical systems installed within enclosure, including but not limited to damage to camera, heater and blower circuitry, cooling circuitry and other systems installed in unit.
- All screws on hinged lower must be tightened to create seal on enclosure. Failure to create this seal may result in water incursion into enclosure. This may lead to electrical shock, failure and damage to electrical systems installed within enclosure, including but not limited to damage to camera, heater and blower circuitry, cooling circuitry and other systems installed in unit.
- Do not over tighten any Screws, Stand Offs, or other fasteners on this unit. Failure to heed this warning will cause damage or failure of the D2 enclosure.
- Be sure to take extra care to Protect Lens of unit prior to and during installation, and during service. Suspension packaging box is a handy platform to protect lens and enclosure, while installing camera and accessory electronics before installation. Failure to protect lens will adversely affect product perform

## Component Check List Included Standard Hardware for Camera Mounting

ITEM NO.	PART NUMBER	QTY.
1	CB-1007 V4	1
2	#8-32 Hexnut	8
3	0.125in male-male standoff	4
4	0.375in standoff	4
5	0.5" standoff	4
6	0.75" standoff	4
7	1" standoff	4
8	1.5" standoff	4
9	0.25" Narrow Washer	2
10	0.25" Lock Washer	1
11	0.25"-20 .375" Long Hex Head Bolt	1
12	#10-32 0.5in Long Screw (Phillips Head)	2
13	#10 Toothed Lock Washer	2
14	#10-32 Hex Nut	2
15	#8-32 0.375" Long Screw (Phillips)	4
16	M3 x 0.5 x 13 Long Screw (Phillips Head)	4
17	0.125 Aluminum Backup Washer	4
18	M3 Toothed Lock Washer	4
19	M3 x 0.5 Nylon Locknut	4

20	24V Input Blue Bypass Cable	1
----	-----------------------------	---

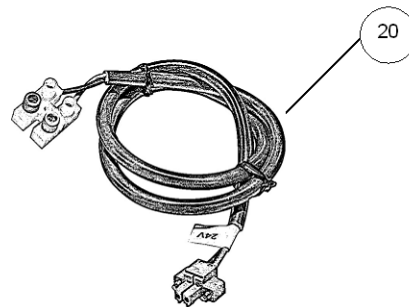
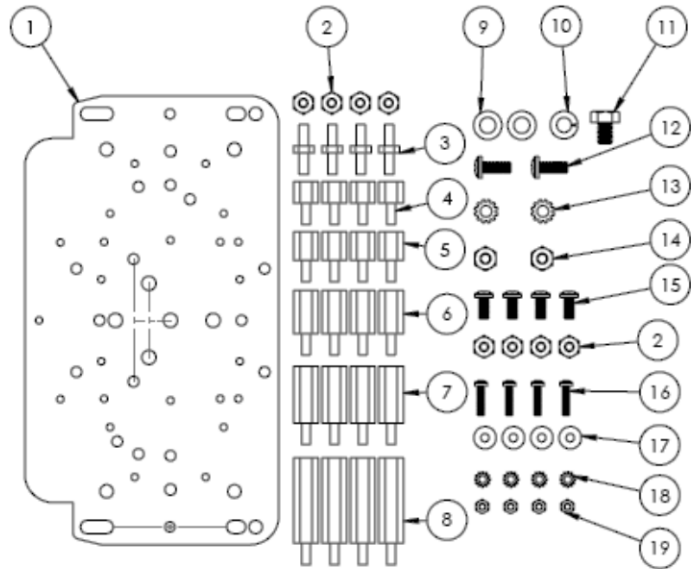

### Optional AB-1007 Camera Mount Bracket for Larger Cameras

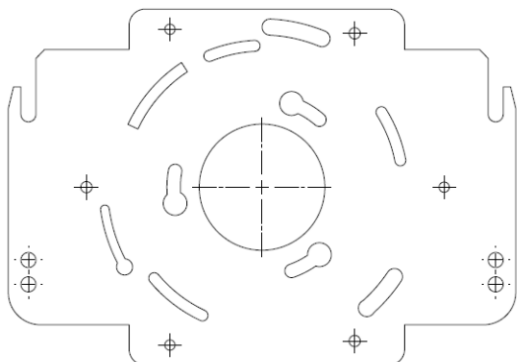

**Optional AB-1007 Bracket Direct Compatibility:**

- (Available by special order)
- Axis 231D, & 232D
- DVTeI 9840
- Merit-LiLin PIH-7000/7600/7625
- PiXORD P-463T Fast Speed Dome
- Pelco Spectra IV
- Sony SNCRH124, SNC-RS44N, SNC-RS46N
- Toshiba IK-DP30A

## MVP Voltage Matrix: Enclosure Input – Camera Output

### Input Voltage to Enclosure

The MVP Enclosures can be powered by Inputs of either High Voltage **110-220 VAC**. Or Low Volt **24 VAC/ VDC**

**Site Power Available**



**110 – 220 VAC**  
Power Source – Single Phase Only



***Or***

**Site Power Available**



**24 VAC/VDC**  
Step Down Transformer  
High Voltage to 24 VAC



### **Voltage Matrix for Input / Output**



Input Voltage: To Power D2	Output Voltage: To Power Camera	12V DC +	24V AC ~	24V DC +
110-220 VAC ~	✓		✓	
24V AC ~	✓	✓		
24V DC +	✓		✓	

### Output Voltage to Power Camera

MVP provides step down voltage to supply camera power for 12VDC, and 24V Cameras. 24V Camera Supply 24V output depends on Site Power Input, for either 24V Direct Current, or Alternating Current (see table above)

*Power Chassis integrated into D-Series MVP*



\*Optional 24VAC Transformer Module available for 24VAC only cameras to convert 110-220 VAC to 24 VAC. (sold separately)

# Input Power Configuration for 24 VAC/ VDC

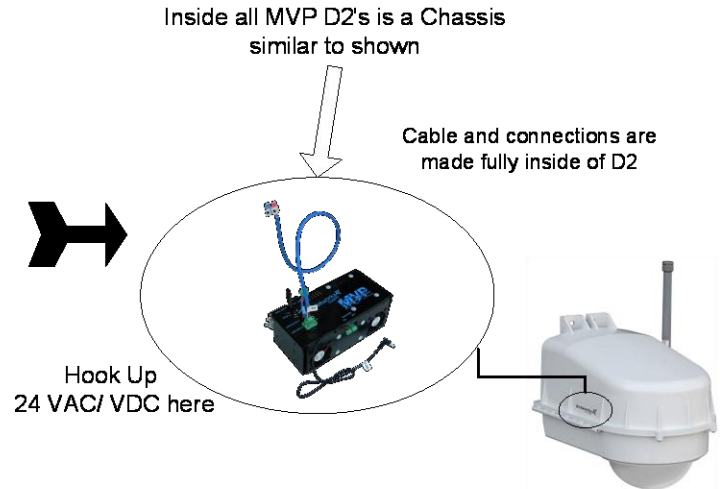
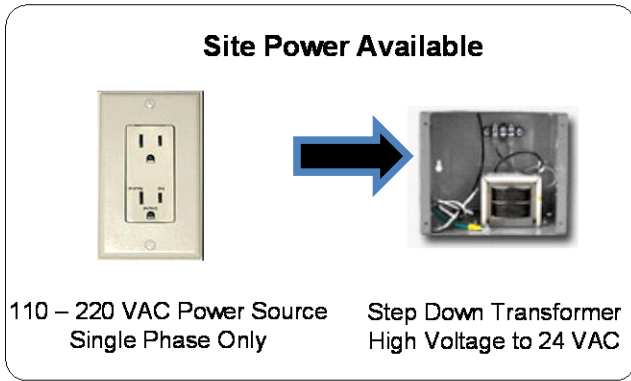

The MVP comes ready for 110-220VAC Input power

To use 24 VAC/VDC you must take a moment to allow input configuration for Low Voltage Input Use Blue 24 VAC Bypass Cable To hook up Power inside D2

Locate 24V Blue Bypass Cable in Hardware Pack Provided

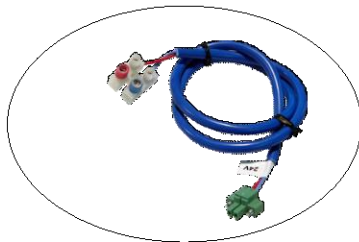

Locate Green Plug on Chassis Then Unplug from panel mount socket, then push aside

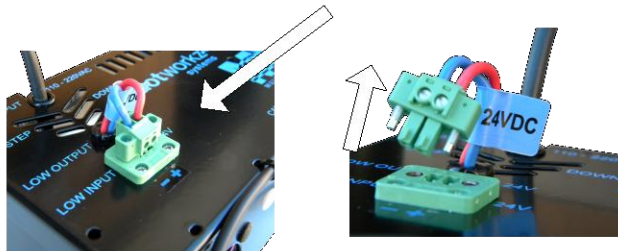

Then insert similar Plug on Blue Bypass Cable Tighten screws on plug to secure

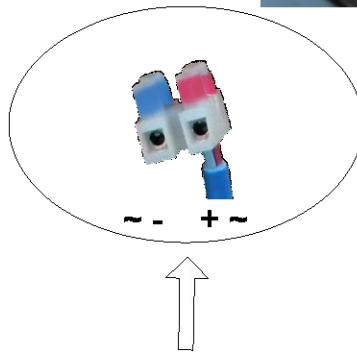
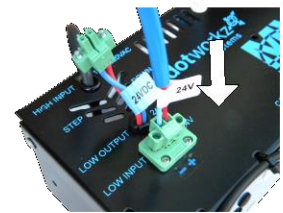

Run 24V into D2 and Connect wires to appropriate Color coded terminal shown here





## Input Power Configuration for 110 – 220 VAC

**Site Power Available**



110 – 220 VAC Power Source –  
Single Phase Only

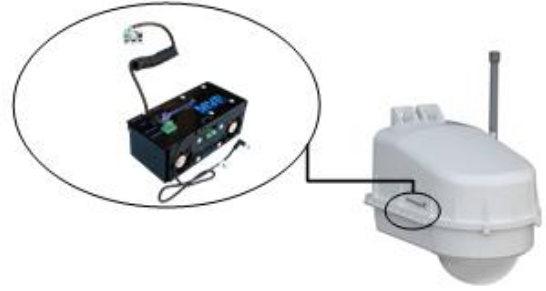

Use Black Coiled Cable for High Voltage Input to hook up Power inside D2



Run 110-220 VAC into D2 and Connect wires to appropriate Color Coded terminal shown here



**Input Specifications**

Input Voltage: 90-264 VAC, (127-370 VDC)  
 Frequency Range: 47- 63 HZ  
 Input Current @ Full Load(Typ.): 1.8A@115VAC, 1.0A@230VAC  
 Recommended Min. Circuit Breaker: 6 A (type C)  
 Int. Electrical. Working Temp\*: -20 ~ +70C  
 MTBF: 353.6Khrs min. MIL-HDBK-217F(25C)

**High Voltage A/C Typical Conventions, single phase (USA wiring convention):**

Color	Symbol	Description
Black	L	Line Conductor, aka: "Hot" wire
White	N	Neutral Conductor
Green	G	Ground Wire, Chassis Ground

**Power Available to Camera & Accessories (max.)**

MVP using 110/ 220 VAC input to D2/ D3

Using **ONE** Output

Using **BOTH** Output Channels (12VDC & 24VDC)

Model	12 VDC Output	OR	24 VDC	12 VDC Output	AND	24 VDC	=	Total
Heater Blower	25 watts	or	25 watts	(A) watts	+	(B) watts	=	25 watts total
Tornado	25 watts	or	25 watts	25 watts max.	+	15 watts	=	40 watts total
Ring of Fire	25 watts	or	25 watts	(A) watts	+	(B) watts	=	25 watts total

## Camera Power / Output Power for MVP

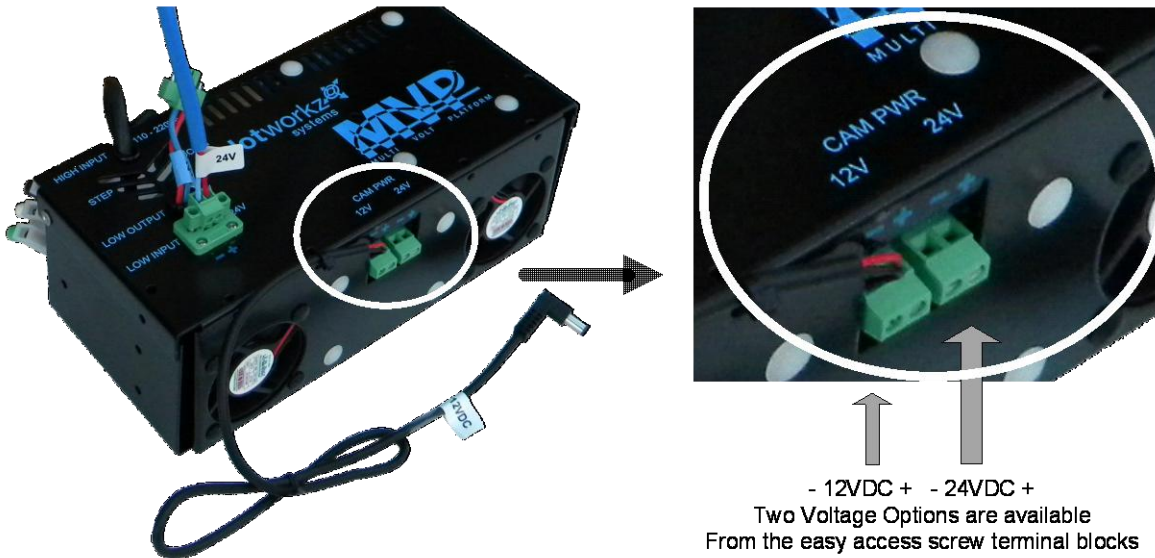

The MVP comes prewired with a 12VDC power cable ready to plug in to some of the most common camera models. However, if your camera has a different power need, the MVP can easily adapt to most camera power needs.

All D2 environmental enclosures come standard with a **12VDC Right Angle Barrel Plug (3.3mm x 5.5mm with a 1mm center pin)** for majority of the IP cameras on the market.

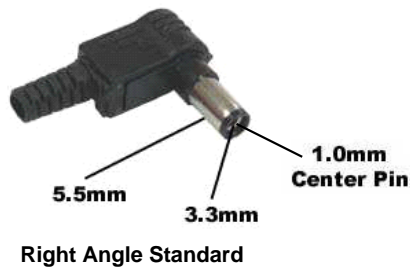

If your IP camera's power connector is different but still accepts up to ~ 13VDC for power, please see our section on **Camera Power Setup (NON-STANDARD CONNECTOR)** for instructions on how to power your camera. Below are pictures of typical NON-STANDARD CONNECTORS.



DC plugs with NO center pin



Terminal pin connectors



Terminal connector

## Generic Camera Installation



The D2 Enclosure series are designed and engineered for today's most popular standard IP based PTZ cameras. The combination of standoff spacing and camera bracket allows our customers to tailor the D2 Enclosure series to their specific camera needs. We have provided the necessary tools for customization with all of our D2 Enclosure series.

The D2 Enclosure series can accommodate mini-domes and PTZ cameras as tall as 9.375 inches in height. Our standoff combination includes supported heights of **0.50", 0.75", 1.00", 1.25", 1.50", 1.75", 2.00", 2.25", 2.50", 2.75", 3.00", and 3.75"**. These standoff heights can be applied to upper and lower mount locations based on the height of your camera. Most cameras will often utilize a center screw hole for securing the camera onto the plate.

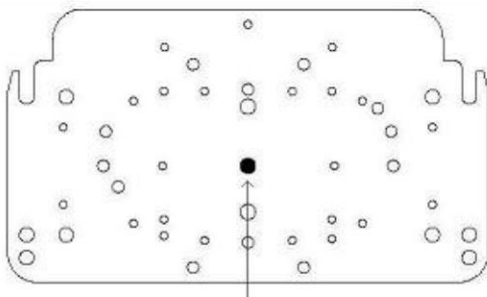

Attach Camera using this hole

If your camera has other mounting capabilities, then center the camera on our camera bracket and check to see if it aligns with any of the pre-made holes on the camera bracket. If it does, great you can use the pre-made holes. If it doesn't, you can mark the holes needed and drill them into the camera plate (steel plate).

*For power, all of our D2 Environmental Enclosure Series come standard with a **12VDC Barrel plug with a center pin**. If your camera does not support this, then check our section on **Camera Power Setup (NON-STANDARD CONNECTOR)** for details.*



Lower Lens Section



Upper D2 Dome Section

## Stand Off Assembly Key for Camera Height Adjustment

ITEM NO.	HEIGHT	STAND OFFS
1	2.000	1 1/2" stand off + 1/2" stand off Or two 1" stand offs
2	1.875	1" stand off + 3/4" stand off + 8-32 Hex nut
3	1.750	1" stand off + 3/4" stand off
4	1.625	1 1/2" stand off + 8-32 Hex nut Or 1" stand off + 1/2" stand off, Plus 8-32 Hex nut Or two 3/4" stand offs + 8-32 Hex nut
5	1.500	Use standard size provided Or 1" stand off + 1/2" stand off Or two 3/4" stand offs
6	1.375	1" stand off + 3/8" stand off
7	1.250	3/4" stand off + 1/2" stand off
8	1.125	1" stand off + 8-32 Hex nut
9	1.000	Use standard size provided Or two 1/2" stand offs
10	0.875	3/4" stand off + 8-32 Hex nut Or 1/2" stand off + 3/8" stand off
11	0.750	Use standard size provided
12	0.625	1/2" stand off + 8-32 Hex nut
13	0.500	Use standard size provided
14	0.375	Use 3/8" standard size provided
15	0.250	Use 1/8" male-male standoff + 8-32 Hex nut
16	0.125a	Use 1/8" male-male standoff
17	0.125b	Or: Use #8-32 Hex nut

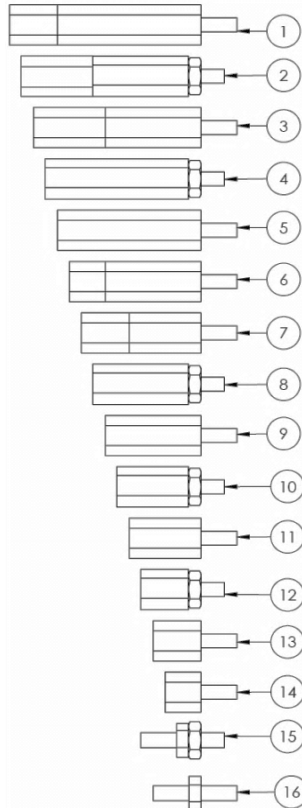

Camera mount stand offs can be adjusted to any height from 0" to 3.75" using assembly logic illustrated above. By utilizing both the camera mounts inside the D2; the upper mounts, and the lower mounts around the lens on hinged lower of D2, virtually any PTZ or Mini-Dome Camera can be mounted into the enclosure at any level. It is best to utilize a mounting strategy that uses the least amount of stand offs, by utilizing the camera mounts inside the D2 that are closest to optimal camera height for stability reasons.

## Installing Camera Bracket

Axis 213 PTZ

Canon VB-C50iR



Required components (see component checklist): Part# 1,2,3,5,6,9,10,& 11

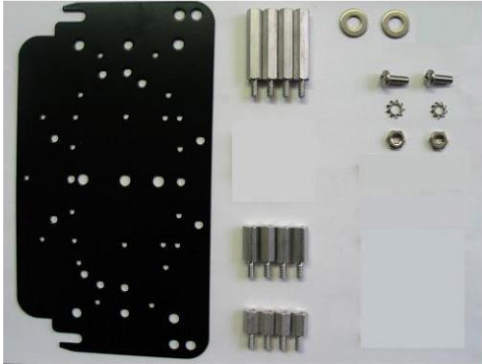

This edge nests in arch at front of D2

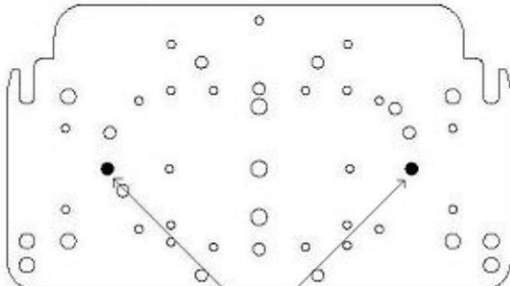

This edge of the bracket faces back of the D2 enclosure  
Attach Camera using these 2 holes

1. Install the Axis 213 PTZ or Canon VB-C50iR camera onto the D2 Camera Bracket with (2) #10-32 screws, (2) #10 Lock Washers, and (2) #10 Locknut that are included.

2. The Axis 213 PTZ or Canon VB-C50iR camera requires a 2" spacing for optimal fit and operation. Use (1) 1.5" standoffs and (1) .5" standoffs that are provided to create a 2" standoff. You will need to create 4 of these with the included hardware.



3. The 2" standoffs will be inserted on the lower lens portion of the D2.

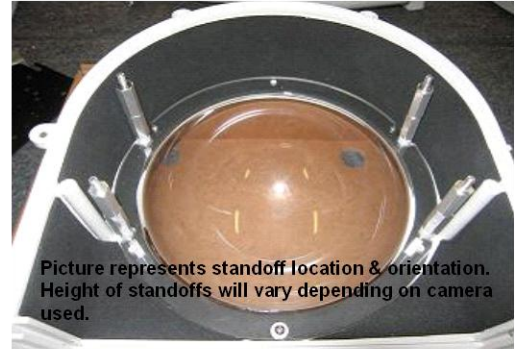

Picture represents standoff location & orientation. Height of standoffs will vary depending on camera used.

4. Now slide the camera bracket with the camera into place to line up with 4 screws from the standoffs.

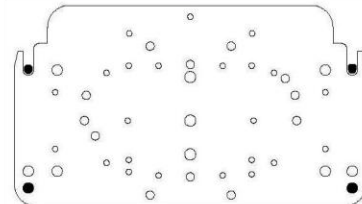

5. Secure the plate by using (4) .75" standoffs to lock the bracket in place. The two front location will require the use of (2) .25" washer.

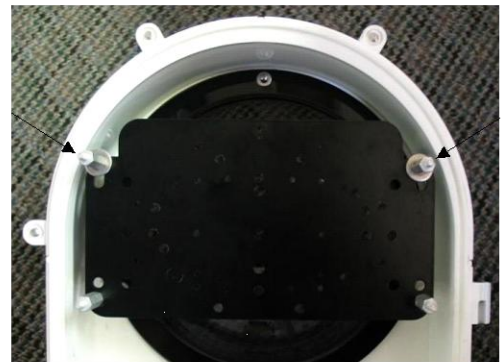

Picture represents camera bracket orientation & how it is secured. Don't forget to mount your camera to the D2 camera bracket based on instructions.

## Installing Camera Bracket

### Axis 214 PTZ



Required components (see component checklist): Part # 1,3,5,12,14,15,& 16

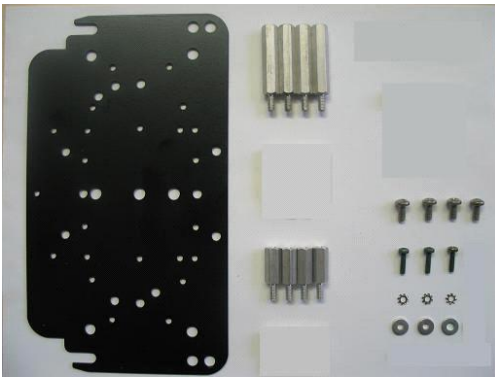

This edge nests in arch at front of D2

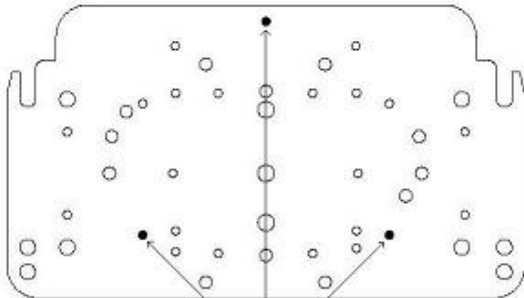

This edge of the bracket faces back of the D2 enclosure  
Attach Camera using these 3 holes

1. Install the Axis 214 PTZ camera onto the D2 Camera Bracket with (3) m3-.5 screws, (3) m3 external lock washers, and (3) m3 1/8" washer that are included.

2. The Axis 214 PTZ camera requires a **2.25"** spacing for optimal fit and operation. Use (1) 1.5" standoffs and (1) .75" standoffs that are provided to create a **2.25"** standoff. You will need to create 4 of these with the included hardware.

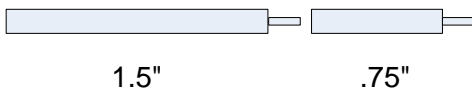

3. The 2.25" standoffs will be inserted on the upper portion of the D2.



Picture represents standoff location & orientation. Height of standoffs will vary depending on camera used.

4. Now slide the camera bracket with the camera into place to line up with 4 screws holes from the standoffs.

5. Use (4) #8-32 screws (Phillips head) to secure the bracket into place.



Tip: Insert (2) #8-32 screws in the front two standoffs to provide a guide to slide the camera bracket into. The last two corner holes should line up and be secured last.



Again, make sure the camera bracket is facing the right direction.

Picture represents camera bracket orientation & how it is secured. Don't forget to mount your camera to the D2 camera bracket based on instructions.

## D2 Mounting Instructions for Axis 231D & 232D

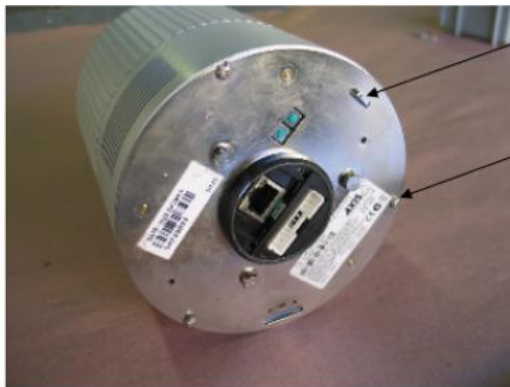

View of Base Plate on Axis 232D

D2 Camera mount Plate

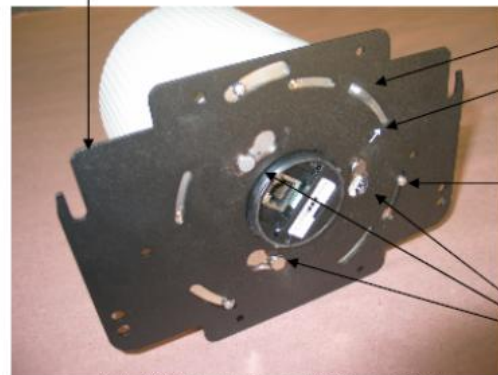

Axis 232D Locked onto D2 Camera Plate

These cameras require the AB-1007 alternate camera bracket shown below, created for cameras with larger mounting bases. It may be ordered directly from Dotworkz, or through your authorized Dotworkz Dealer.

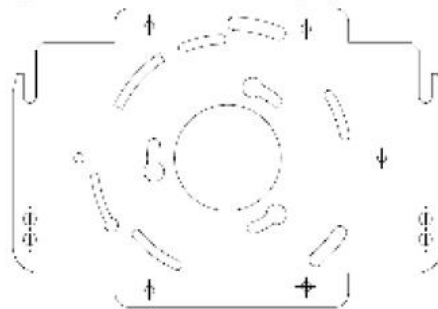

AB-1007 Camera Bracket (Available upon request)

- 1) Orient Axis 231D/ 232D to view mounting base as shown in first image.
- 2) Locate Alignment tab on camera base, and set screw located just below tab as shown in picture. (left)
- 3) Loosen set screw, backing it out of camera base to approximately 1/8" or more.
- 4) Locate Camera mount plate and take note of printed arrow on bottom of plate.
- 5) Align 3 tee posts on camera base with widest part of corresponding key holes on the D2 camera mount plate; taking note that arrow on plate will align with alignment tab on the camera, before rotating plate.
- 6) Rotate plate clockwise to set Tee posts into key holes.
- 7) Finish mounting to the D2 plate by tightening (clockwise) set screw head firmly against D2 camera mount plate.
- 8) For the proper offset of these cameras into the D2 enclosure's lens. The Axis 231D & 232D will require four 1" stand offs (part ID #4) pre installed onto the corresponding four threaded inserts on the inside front of the D2's upper shell. (see lower right image on pg 5 of D2 Product Instructions)
- 9) Using wiring harness provided with your camera, and customer provided cat 5 cabling, installer should ready wiring hook up within the D2 enclosure, for final camera placement into the D2 enclosure.
- 10) Place Axis 231D/ 232D near mouth of enclosure, and hook up harness and cat 5e wires, plugging into camera.
- 11) Use four #8-32 x 3/8" (part ID #12) pan head machine screws, provided in fastener package of D2's hardware bag, and secure camera mount plate on top of four 1" stand offs mounted in step #8 above. Tighten all 4 of the #8-32 fasteners, securely fastening camera plate into D2.
- 12) Pre test all clearances, and power connections before closing D2 enclosure. Make adjustments as needed.

# Installing Camera Bracket

Axis 233D PTZ



Required components (see component checklist): Part # 1,2,3,9,10,11,& 12

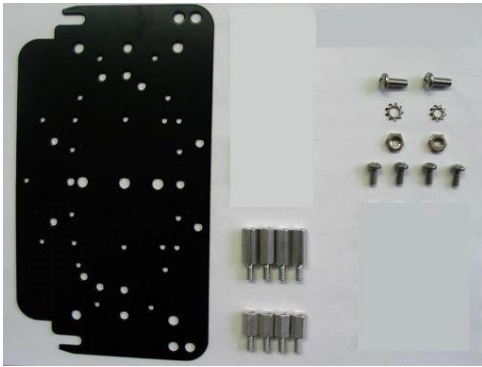

This edge nests in arch at front of D2

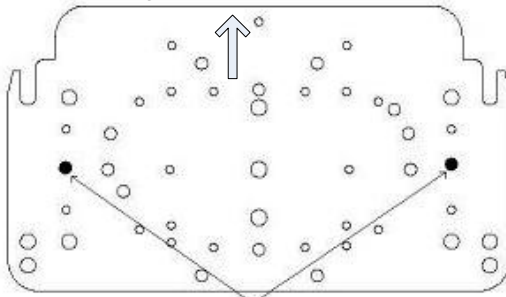

Attach Camera using these 2 holes

This edge of the bracket faces back of the D2 enclosure

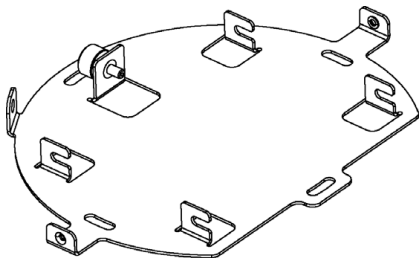

Axis 233D Ceiling bracket that came with the camera. **\*This is a required item for installation\***

1. To install the Axis 233D in the D2 Enclosure we must first install the Axis 233D ceiling bracket adapter that came with the camera onto the D2 camera mounting plate.

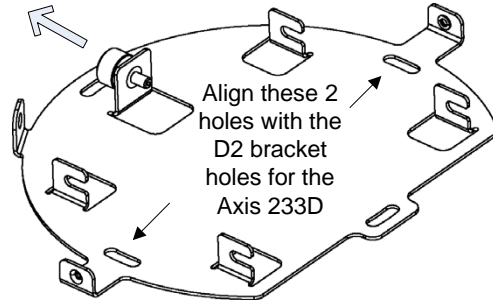

Axis 233D Ceiling bracket that came with the camera. **\*This is a required item for installation\***

2. Do this by aligning the two holes on the D2 camera bracket with the Axis ceiling bracket adapter. Use (2) #10-32 1/2" long screws, (2) #10 lock washers, and (2) #10-32 hex nuts that are included to secure the axis ceiling adapter to the D2 camera bracket.

3. Next follow the Axis 233D installation instruction to secure the camera to the ceiling bracket adapter that is now attached to the D2 Camera Bracket.

4. The Axis 233D PTZ camera requires a 1.25" spacing for optimal fit and operation. Use (1) .75" standoffs and (1) .5" standoffs that are provided to create a 1.25" standoff. You will need to create 4 of these with the included hardware.

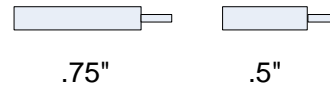

5. The 1.25" standoffs will be inserted on the upper portion of the D2.





## Installing Camera Bracket

### Axis 233D PTZ



Continued . . . . .

6. Now slide the camera bracket with the camera into place to line up with 4 screws holes from the standoffs.

7. Use (4) #8-32 screws (Phillips head) to secure the bracket into place.

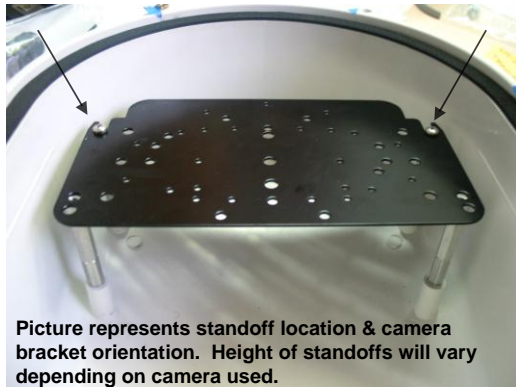

Picture represents standoff location & camera bracket orientation. Height of standoffs will vary depending on camera used.

Tip: Insert (2) #8-32 screws in the front two standoffs to provide a guide to slide the camera bracket into. The last two corner holes should line up and be secured last.



Picture represents camera bracket orientation & how it is secured. Don't forget to mount your camera to the D2 camera bracket based on instructions.

## Installing Camera Bracket

Canon VB-C300



Required components (see component checklist): Part# 1,2,3,5,6,7,& 8

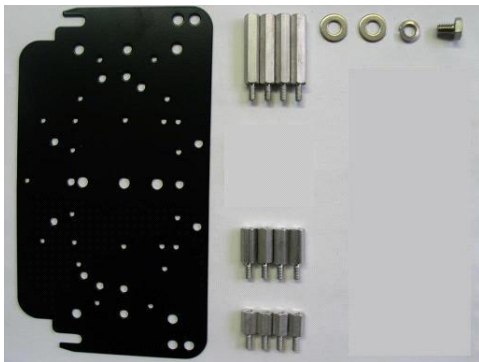

This edge nests in arch at front of D2

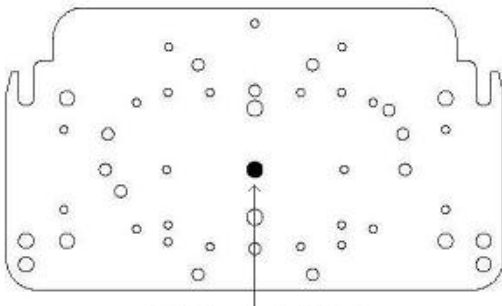

Attach Camera using this hole

This edge of the bracket faces back of the D2 enclosure

1. Install the Canon VB-C300 camera onto the D2 Camera Bracket center hole with (1) .25"-20 3/8" Long Bolt, and (1) .25" Lock Washer that are included.

2. The Canon VB-C300 camera requires a 2" spacing for optimal fit and operation. Use (1) 1.5" standoffs and (1) .5" standoffs that are provided to create a 2" standoff. You will need to create 4 of these with the included hardware.



3. The 2" standoffs will be inserted on the lower lens portion of the D2.



Picture represents standoff location & orientation. Height of standoffs will vary depending on camera used.

4. Now slide the camera bracket with the camera into place to line up with 4 screws from the standoffs.

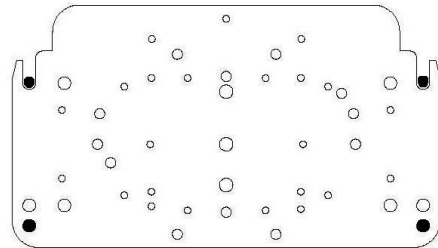

5. Secure the plate by using (4) .75" standoffs to lock the bracket in place. The two front location will require the use of (2) .25" washer.

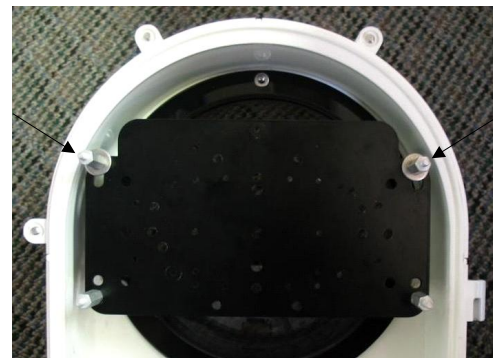

Picture represents camera bracket orientation & how it is secured. Don't forget to mount your camera to the D2 camera bracket based on instructions.

# Installing Camera Bracket

Panasonic NS-202



Required components (see component checklist): Part# 1,2,4,5,6,7,& 8

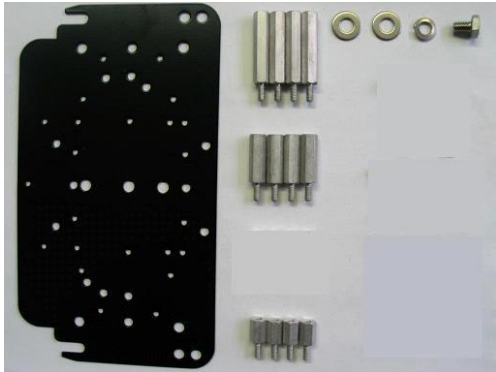

This edge nests in arch at front of D2

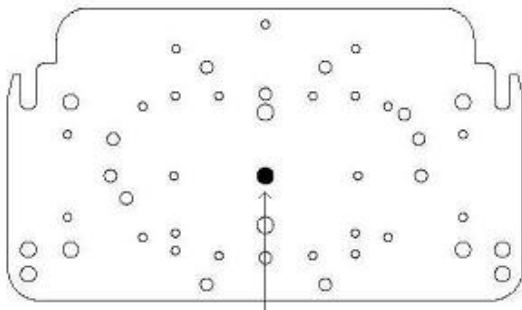

Attach Camera using this hole

This edge of the bracket faces back of the D2 enclosure

1. Install the Panasonic NS-202 camera onto the D2 Camera Bracket center hole with (1) .25"-20 3/8" Long Bolt, and (1) .25" Lock Washer that are included.

2. The Panasonic NS-202 camera requires a **2.5"** spacing for optimal fit and operation. Use (1) 1.5" standoff and (1) 1.0" standoff that are provided to create a **2.5"** standoff. You will need to create 4 of these with the included hardware.

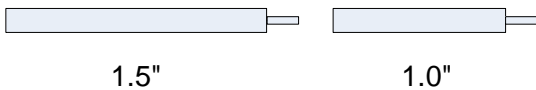

3. The 2.5" standoffs will be inserted on the lower lens portion of the D2.



Picture represents standoff location & orientation. Height of standoffs will vary depending on camera used.

4. Now slide the camera bracket with the camera into place to line up with 4 screws from the standoffs.

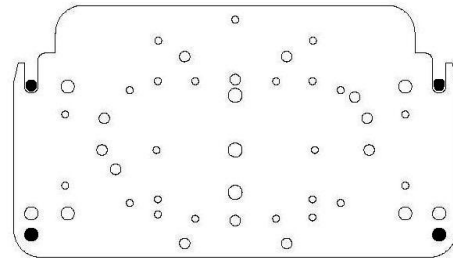

5. Secure the plate by using (4) .5" standoffs to lock the bracket in place. The two front location will require the use of (2) .25" washer.

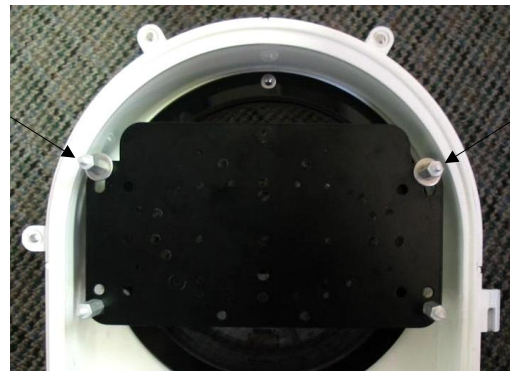

Picture represents camera bracket orientation & how it is secured. Don't forget to mount your camera to the D2 camera bracket based on instructions.

# Installing Camera Bracket

Panasonic BB-HCM381/  
580/581 & KX-HMC280



Required components (see component checklist): Part# 1,2,3,5,6,7,& 8

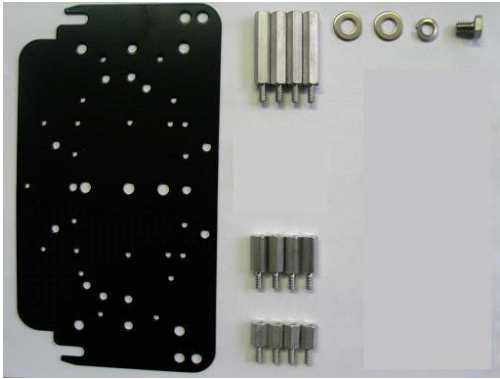

This edge nests in arch at front of D2

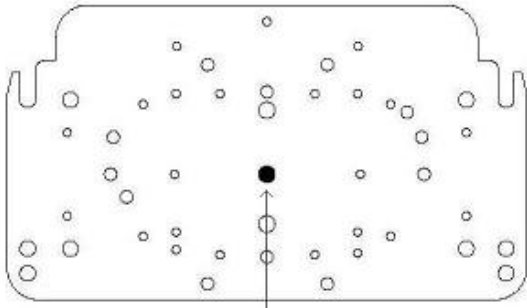

Attach Camera using this hole

This edge of the bracket faces back of the D2 enclosure

1. Install the Panasonic camera onto the D2 Camera Bracket center hole with (1) .25"-20 3/8" Long Bolt, and (1) .25" Lock Washer that are included.

2. The Panasonic camera requires a **2.0"** spacing for optimal fit and operation. Use (1) 1.5" standoff and (1) .5" standoff that are provided to create a **2.0"** standoff. You will need to create 4 of these with the included hardware.

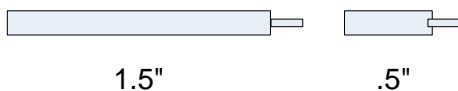

3. The 2.0" standoffs will be inserted on the lower lens portion of the D2.



Picture represents standoff location & orientation. Height of standoffs will vary depending on camera used.

4. Now slide the camera bracket with the camera into place to line up with 4 screws from the standoffs.

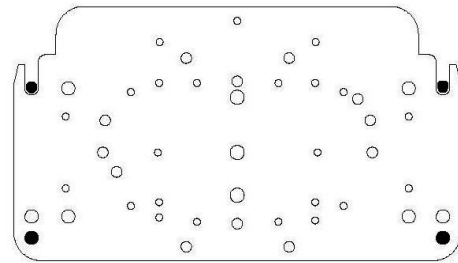

5. Secure the plate by using (4) .75" standoffs to lock the bracket in place. The two front location will require the use of (2) .25" washer.

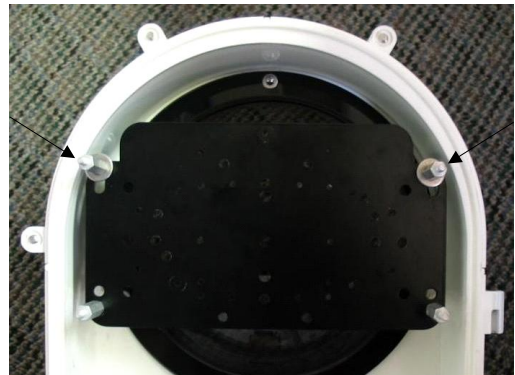

Picture represents camera bracket orientation & how it is secured. Don't forget to mount your camera to the D2 camera bracket based on instructions.

## Installing Camera Bracket

Sony RZ25N



**Required components (see component checklist): Part # 1,2,3,12,14,15,& 16**

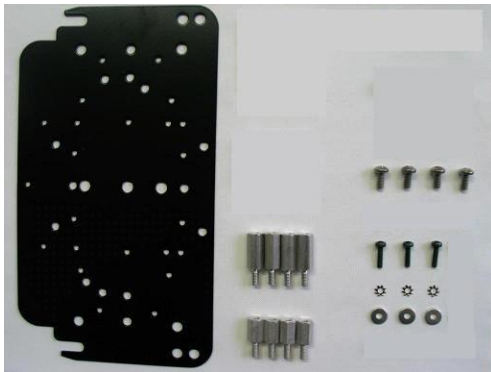

This edge nests in arch at front of D2

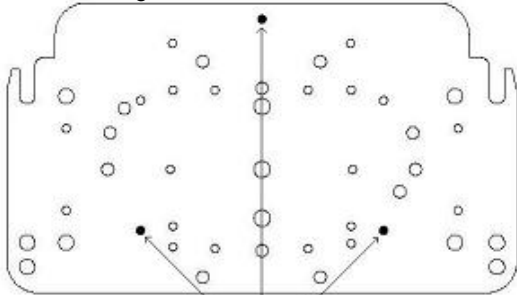

This edge of the bracket faces back of the D2 enclosure  
Attach Camera using these 3 holes

1. Install the Sony RZ25N camera onto the D2 Camera Bracket with (3) m3-.5 1/2" Long screw (3) m3 External Lock Washer, and (3) m3 1/8" Washer that are included.



Tip: Don not screw all the way through. Screw them in enough to catch some thread on all three screw locations. Once all three screw catch enough thread, begin tightening one at a time.

2. The Sony RZ25N camera requires a **1.25"** spacing for optimal fit and operation. Use (1) .75" standoffs and (1) .5" standoffs that are provided to create a **1.25"** standoff. You will need to create 4 of these with the included hardware.

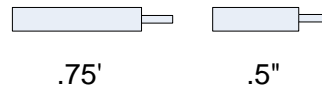

3. The 1.25" standoffs will be inserted on the upper portion of the D2.



4. Now slide the camera bracket with the camera into place to line up with 4 screws holes from the standoffs.

5. Use (4) #8-32 screws (Phillips head) to secure the bracket into place.



Tip: Insert (2) #8-32 screws in the front two standoffs to provide a guide to slide the camera bracket into. The last two corner holes should line up and be secured last.



Picture represents camera bracket orientation & how it is secured. Don't forget to mount your camera to the D2 camera bracket based on instructions.

# Installing Camera Bracket

Sony RZ30N



Required components (see component checklist): Part # 1,2,3,6,7,8,12, & 14

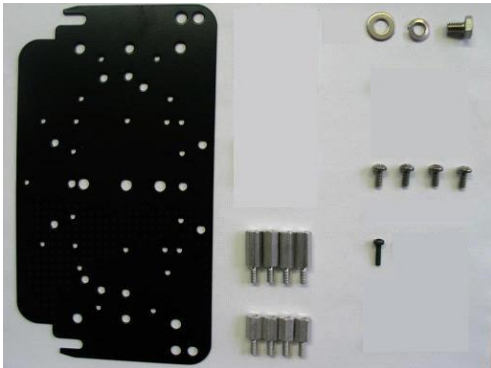

This edge nests in arch at front of D2

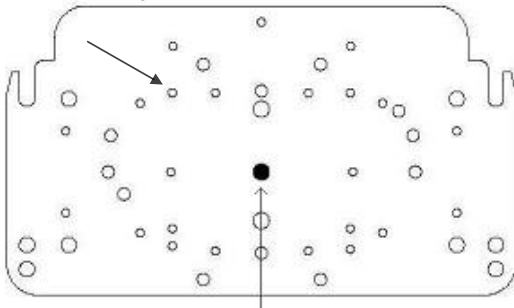

Attach Camera using this hole

This edge of the bracket faces back of the D2 enclosure

1. Install the Sony RZ30N camera onto the D2 Camera Bracket center hole with (1) .25"-20 3/8" Long Bolt, (1) .25" Lock Washer, and (1) .25" Washer that are included.

2. Use (1) m3-.5 1/2" long screw in the second corner hole to prevent the Sony RZ30N from moving left and right. The screw will protrude out from the bracket about 1/4". The Sony RZ30N should have a threaded hole that will align with the second corner hole.



3. The Sony RZ30N camera requires a 2.25" spacing for optimal fit and operation. Use (1) 1.5" standoffs and (1) .75" standoffs that are provided to create a 2.25" standoff. You will need to create 4 of these with the included hardware.



4. The 2.25" standoffs will be inserted on the upper portion of the D2.



Picture represents standoff location & orientation. Height of standoffs will vary depending on camera used.

5. Now slide the camera bracket with the camera into place to line up with 4 screws holes from the standoffs.

6. Use (4) #8-32 screws (Phillips head) to secure the bracket into place.



Tip: Insert (2) #8-32 screws in the front two standoffs to provide a guide to slide the camera bracket into. The last two corner holes should line up and be secured last.

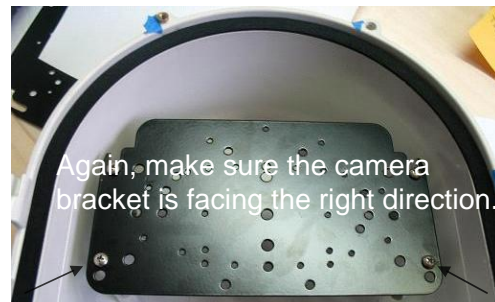

Again, make sure the camera bracket is facing the right direction.

Picture represents camera bracket orientation & how it is secured. Don't forget to mount your camera to the D2 camera bracket based on instructions.

# Installing Camera Bracket

**Sony RZ50N**



**Required components (see component checklist): Part # 1,4,5,6,7,8,& 12**

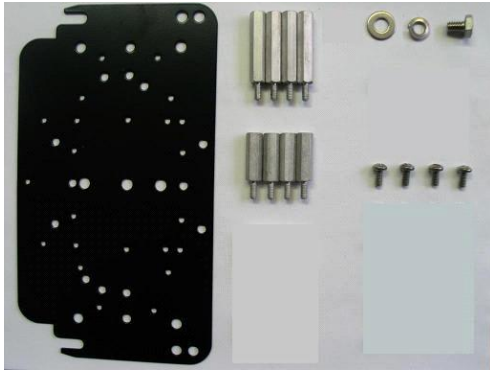

This edge nests in arch at front of D2

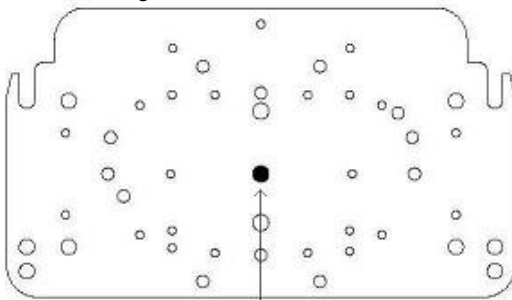

Attach Camera using this hole

This edge of the bracket faces back of the D2 enclosure

1. Install the Sony RZ50N camera onto the D2 Camera Bracket center hole with (1) .25"-20 3/8" Long Bolt, (1) .25" Lock Washer, and (1) .25" Washer that are included.

2. The Sony RZ50N camera requires a **2.5"** spacing for optimal fit and operation. Use (1) 1.5" standoffs and (1) 1" standoffs that are provided to create a **2.5"** standoff. You will need to create 4 of these with the included hardware.

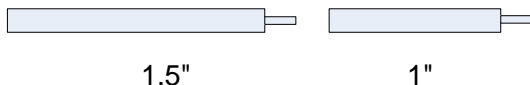

3. The 2.5" standoffs will be inserted on the upper portion of the D2.



Picture represents standoff location & orientation. Height of standoffs will vary depending on camera used.

4. Now slide the camera bracket with the camera into place to line up with 4 screws holes from the standoffs.

5. Use (4) #8-32 screws (Phillips head) to secure the bracket into place.



Tip: Insert (2) #8-32 screws in the front two standoffs to provide a guide to slide the camera bracket into. The last two corner holes should line up and be secured last.



Again, make sure the camera bracket is facing the right direction. Picture represents camera bracket orientation & how it is secured. Don't forget to mount your camera to the D2 camera bracket based on instructions.

## Installing Camera Bracket

Sony RX550N



Required components (see component checklist): Part # 1,2,12,14,15, & 16

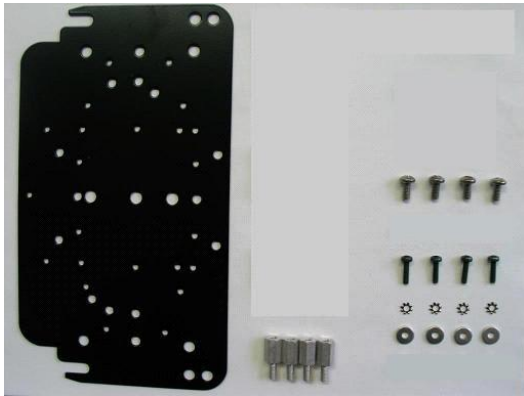

This edge nests in arch at front of D2

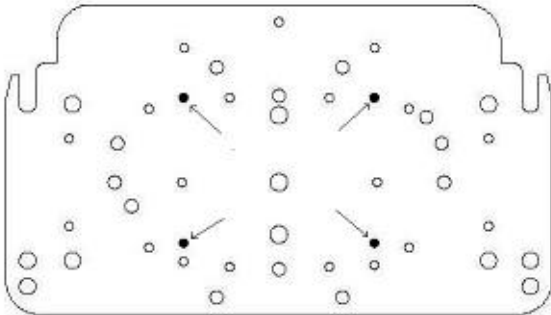

Attach Camera using these 4 holes.

This edge of the bracket faces back of the D2 enclosure

1. Install the Sony RX550N camera onto the D2 Camera Bracket with (4) m3-.5 1/2" long screws, (4) m3 external lock washer, and (4) m3 1/8" washer that are included.

2. The Sony RX550N camera requires a .5" spacing for optimal fit and operation. Use (4) .5" standoffs that are included.

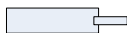

.5"

3. The .5" standoffs will be inserted on the upper portion of the D2.



Picture represents standoff location & orientation. Height of standoffs will vary depending on camera used.

4. Now slide the camera bracket with the camera into place to line up with 4 screws holes from the standoffs.

5. Use (4) #8-32 screws (Phillips head) to secure the bracket into place.



Tip: Insert (2) #8-32 screws in the front two standoffs to provide a guide to slide the camera bracket into. The last two corner holes should line up and be secured last.



Again, make sure the camera bracket is facing the right direction.

Picture represents camera bracket orientation & how it is secured. Don't forget to mount your camera to the D2 camera bracket based on instructions.



## Installing Camera Bracket

Toshiba WB21A



Required components (see component checklist): Part # 1,2,3,4,5,6,14,15,16,& 17

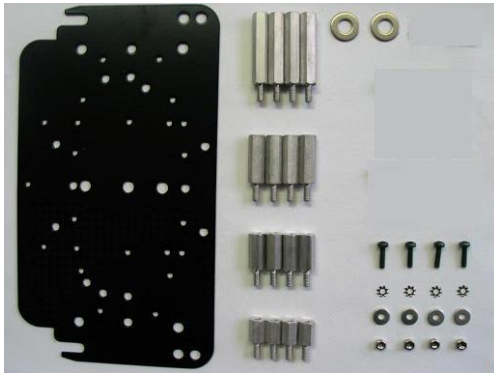

This edge nests in arch at front of D2

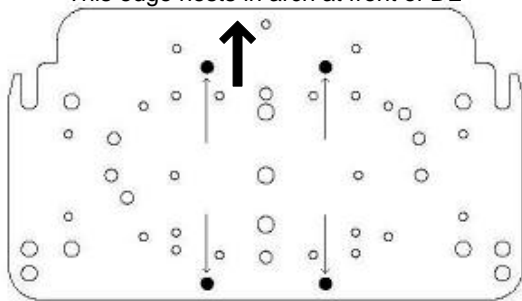

Attach Camera using these 4 holes.

This edge of the bracket faces back of the D2 enclosure

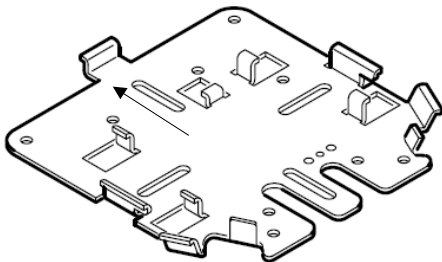

Toshiba WB21A Ceiling bracket that came with the camera.  
**\*This is a required item for installation\***

1. To install the Toshiba WB21A in the D2 Enclosure we must first install the Toshiba WB21A ceiling bracket adapter that came with the camera onto the D2 camera mounting plate.

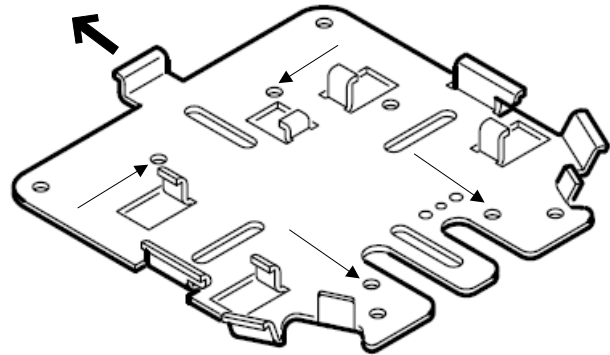

Align these 4 holes with the D2 bracket holes for the Toshiba WB21A

2. Do this by aligning the four holes on the D2 camera bracket with the Toshiba ceiling bracket adapter. Use (4) m3-.5 1/2" long screws, (4) m3 external lock washer, (4) m3 1/8" washers, and (4) m3 lock nuts that are included to secure the toshiba ceiling adapter to the D2 camera bracket.



3. Next follow the Toshiba WB21A installation instruction to secure the camera to the ceiling bracket adapter that is now attached to the D2 Camera Bracket.

4. The Toshiba WB21A PTZ camera requires a **2.75"** spacing for optimal fit and operation. Use (1) 1.5" standoff, (1) .75" standoff, and (1) .5" standoffs that are provided to create a **2.75"** standoff. You will need to create 4 of these with the included hardware.

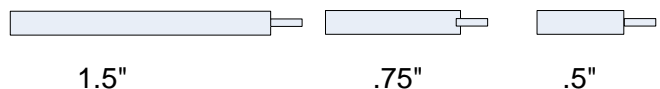

## Installing Camera Bracket

Toshiba WB21A



Continued . . . . .

5. The 2.75" standoffs will be inserted on the lower portion of the D2.



Picture represents standoff location & orientation.  
Height of standoffs will vary depending on camera used.

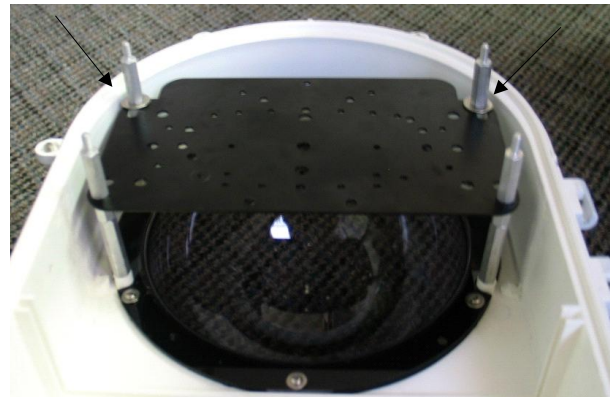

Picture represents camera bracket orientation & how it is secured. Don't forget to mount your camera to the D2 camera bracket based on instructions.

6. Now slide the camera bracket with the camera into place to line up with 4 screws from the standoffs.

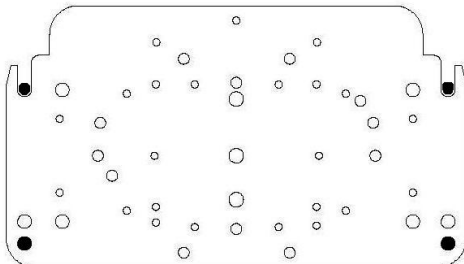

7. Secure the plate by using (4) 1.0" standoffs to lock the bracket in place. The two front location will require the use of (2) .25" washer. See picture.

# COOLDOME Input Power Configuration: D2-CD-12VDC

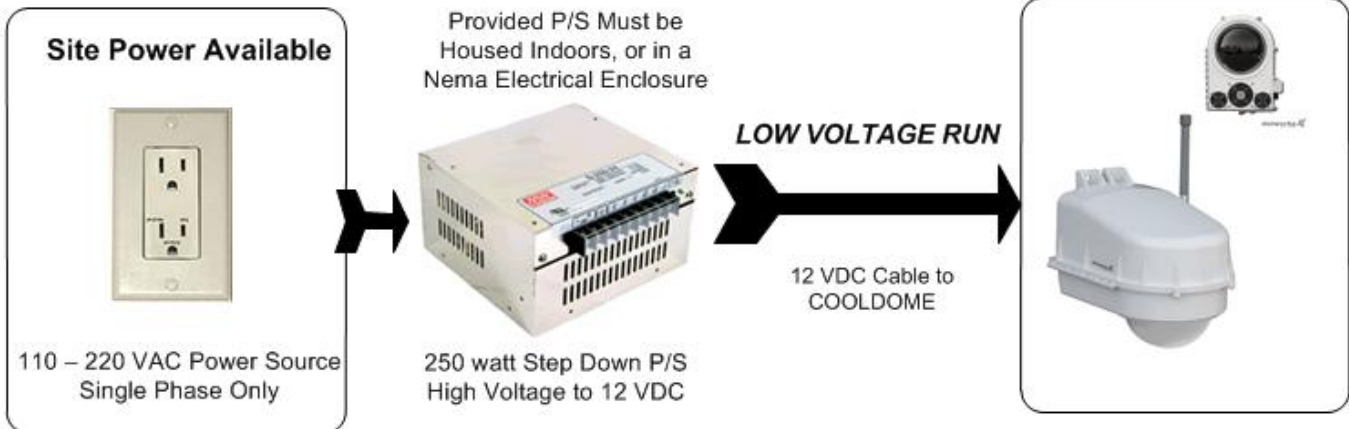

Turn Off Power or leave power disconnected during Installation of All Wiring.  
Follow all local and relevant electrical codes & standards.  
Test all Wiring and confirm correct voltages before wiring up & powering up D2 COOLDOME.

Select Input Voltage before Hooking up Power Supply  
110 VAC or 220 VAC

Rear of Power Supply with Input Voltage Selector



Front of Power Supply with terminal strip



### High Voltage A/C Input, Single Phase, USA Wiring Color Code

Color	Symbol	Description
Black	L	Line Conductor, AKA Live, Hot
White	N	Neutral Conductor
Green	G	Ground Conductor, Safety Ground

### Low Voltage 12 VDC Output Terminals

Color	Symbol	Description
Red	+, V+	Positive VDC
Black	-, V-	Negative VDC

## LOW VOLTAGE RUN: Wire Gauge Chart

### 12 Volts D/C Voltage Drop for Dotworkz D2 Cool Dome

Distance (ft)>>	Wire gauge In AWG (below)							
	1.0 ft	10.0	20.0	30.0	40.0	50.0	100.0	
4.0	0.006	0.062	0.124	0.186	0.248	0.310	0.620	
6.0	0.010	0.098	0.196	0.294	0.392	0.490	0.980	
AWG 8.0	0.016	0.156	0.312	0.468	0.624	0.780	1.560	
10.0	0.025	0.248	0.496	0.744	0.992	1.240	2.480	
12.0	0.040	0.400	0.800	1.200	1.600	2.000	4.000	
14.0	0.063	0.628	1.256	1.884	2.512	3.140	6.280	

Gauge Multiplier  
Vdc drop/ft

Voltage drop (vdc)/ distance (ft)

Acceptable line drop for Wire Gauge and Distance

Excessive line drop for Wire Gauge and Distance

Above includes 9 amps @ 12 vdc for D2 Cool Dome typical current draw, with 3 amps for max. camera & accessory draw. 12 amps max.

# COOLDOME Input Power Configuration: D2-CD-12VDC

## External Power Supply

The output of the S-250-12 external power supply, can be adjusted up and down 10%. It is recommended to keep the voltage at the D2 adjusted to at least 11.5 vdc, but no more than 13.5 vdc. By running the enclosure higher than 13.5 vdc may cause premature fan failure. It is best to check and tune the voltage at the Cool Dome with a voltage meter at the time of installation, and use the adjustment screw, located on the S-250-12, to the right side of the terminal screws, to raise or lower the output voltage.

For all outdoor wiring, always use an outdoor rated wiring, or wiring in weather rated conduit, out from power supply, into the Cool Dome. Follow all local and applicable wiring and safety standards.

**Please keep D/C wire runs short, to reduce low voltage line drop.** Also, the suggested wiring gauge table is provided on previous page to further prevent low voltage line drop, and to guide you in selecting the proper wire gauge for the dc run from the power supply to the cool dome

It is always advisable to use a drip loop on all wiring going directly into the D2 enclosure, to reduce the risk of water entering and damaging internal components. All fittings and seals must be firmly tightened and sealed, before placing the D2 in service.

Inside the D2 we have provided a convenient Screw cage clamp style terminal blocks to wire the 12 vdc positive (V+), and the 12 vdc Negative (V-) terminal. Please strip the insulation off the last 3/8" of the wires and fasten wiring securely to terminal, using a small blade screwdriver to tighten the caging mechanism on the terminal blocks.

*Please be especially attentive to wire using the Proper Polarity, so as not to damage the internal components, or damage your camera within.*

## **LOW VOLTAGE RUN: Voltage Drop Table (shown on prior page)**

Where we conservatively try to keep the voltage drop under 1.2 vdc over the low voltage direct current run. These multipliers are approximate, and voltage drop (Vd) is maximum at full 12 amp load at 12 vdc. This voltage drop is under fully loaded condition, when the cooling unit is engaged, and camera and all accessories are on. Voltage drop will be much less, if the current is not at full load.

### **Power Supply Specifications**

Input Voltage: 90-132VAC/ 176-264VAC Selected by Switch  
Frequency Range: 47- 63 HZ  
Input Current @ Full Load(Typ.): 4A @115VAC, 2A @230VAC  
Recommended Min. Circuit Breaker for 110VAC In: 10 A (type C)  
Int. Electrical Working Temp\*: -20 ~ +70C  
Ext. Power Supply Output: 18A @ 12VDC up to 50C  
Derate 0.5A/ deg. C over 50C

### **COOLDOME Specifications**

Current Draw by COOLDOME @ 12VDC:  
Active Cooler OFF: 0.4A/ Active Cooler Peak On: 10.5A  
Active Cooler On Typ.: 9.0A/ (Cam. Draw Not Incl.)  
MTBF: 238.9Khrs min. MIL-HDBK-217F(25C)



### **Reusable Desiccant Canister**

The reusable desiccant canister contains forty grams of silica gel. This will prevent moisture buildup inside the Cool Dome. Make sure to remove the canister from its foil envelope packaging before the Cool Dome is put to use.

There is a small window on the canister (white circle). Ensure that the crystals are blue. Occasionally, especially in humid environments, the canister may need to be serviced. If so, the crystals in the window turns pink, indicating the silica gel is saturated with moisture and can be reactivated by being placed in an oven at 300 °F for three hours or until the crystals turn blue again. The gel can be reactivated virtually an infinite number of times.

# Optional Steady Step Mounting System

Steady Step Bracket Steps adjust in 1/4" increments. To adjust 1/8" between step settings, add 1/8" brass male-male hex stand-off (ITEM NO. 6) shown in detail D, by threading on top of movable slide bracket, then fastening camera bracket (CB-1007 or AB-1007).

UA-CB Installation  
1/8" Offset

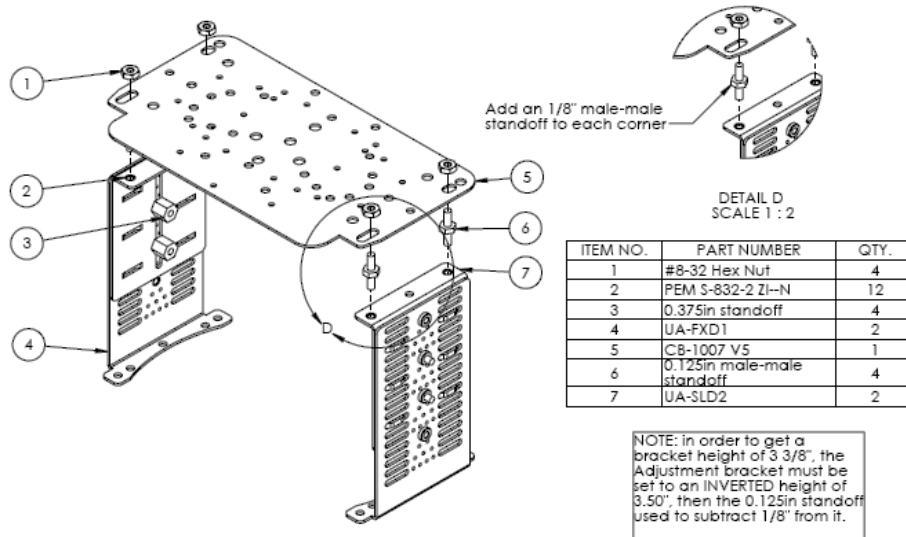

UA-CB Installation  
Example Bracket Heights  
(in 1/4" increment)

NOTE: for 1/8" offsets see next page

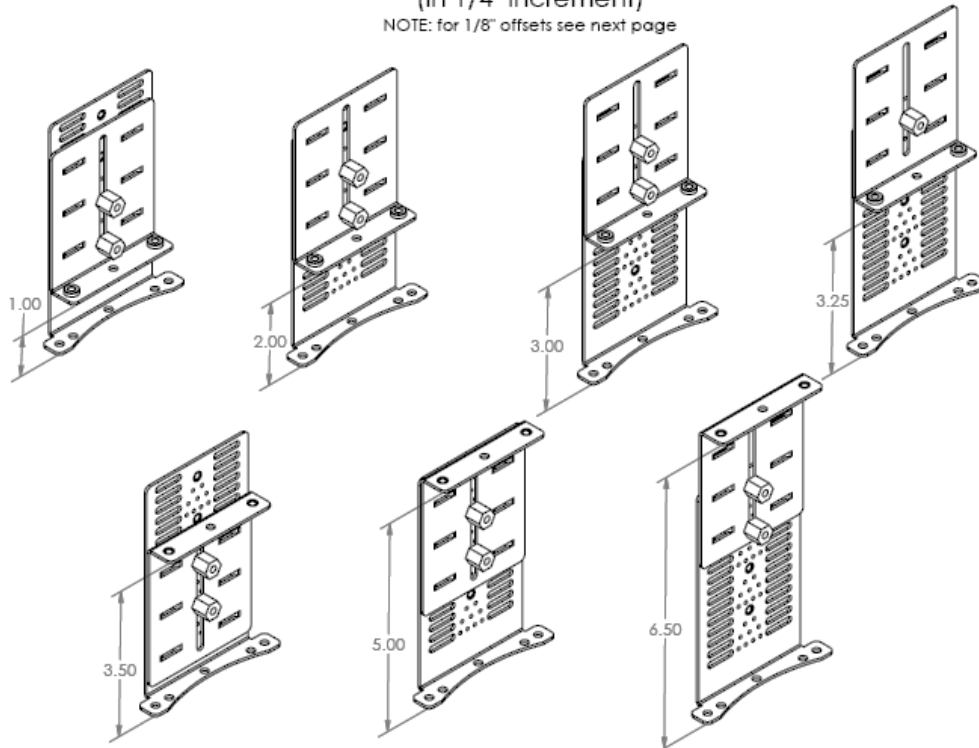



## Electrical Conduit Guidelines

For optimal performance, your D2 Enclosure designed to be Air & Water Tight to eliminate any moisture, dust, and insect damage, safety, performance, reliability, and maintenance related issues.

Use of Electrical Conduit, without sealing the entry ports/ inside wire feeds within Camera Enclosure, will subject the inside of your enclosure to possibility of condensation driven moisture, dust, and insect contamination hazards. Always follow local and national electrical codes for installation. Installation should always be done by a qualified service technician.



Dotworkz has provided each D2 with two Cable Gland Strain Relief seal ports that fully seal enclosure to an IP68 rating, Waterproof and Airtight Seal. (Holes on enclosure are 7/8" diameter, ready for standard 1/2" I.D. NPT connector, or PG13 fittings.)

However, we realize our customers are retrofitting these connectors with electrical conduit fittings. We acknowledge this industry customization and installation practice, and would like to make these suggestions for customers to properly install these products.



### Conduit Suggestions:

- 1) If wires, cabling, or conduit are coming at enclosure wire entry level, or above, always create a drip loop.
- 2) Please use only approved watertight electrical conduit and connectors, IP66 or better, with proper seals and fittings installed & fully seal.
- 3) **Then, after all wire and cables are installed into enclosure, Seal wire entry ports inside of enclosure** with any number of commercially available sealing putty's, Silicone Sealant, or similar products that are approved by applicable local and relevant electrical codes.

Dotworkz supplies two 1/2" diameter foam conduit plugs, that when installed, will assist in sealing off airflow in conduit feed thru, at cable entry inside of enclosure. Putty or Sealant can be used in conjunction with these plugs, to assure a full seal inside enclosure cable feed entry.

### FORCES AT WORK IN ANY UNSEALED, CONDUIT WIRE FEED ENCLOSURE SYSTEM

WARM/MOIST IN UNSEALED CONDUIT MOVES THRU CONDUIT FEEDS EXPAND & CONTRACT WHEN CONDUIT HEATS & COOLS WITH OUTSIDE TEMPERATURES → EXPANDING HEATED AIR IS PUSHED INTO ENCLOSURE THEN COOLS & CONDENSES, HUMID AIR CONDENSES ON SURFACES INSIDE ENCLOSURE



Arrows illustrate air flow within conduit when wire feed is not sealed within enclosure

**SHOCK HAZARD!** hazard, unsatisfactory in the D2 product, electronics due to air collecting in the enclosure

Failure to fully seal enclosure wire and cabling entry ports may lead to shock product performance, a possibility of damage to electronics including camera damage, and damage to integrated driven moisture traveling thru the conduit, condensing and creating a short circuit hazard.



Electrical Putty



Silicone Sealants



Foam Sealants (use very sparingly)

Dotworkz does not endorse, nor has it evaluated any of these products. Test products first, and follow all manufacturers' instructions. Follow all applicable electrical and building codes and installation guidelines. End user assumes liability for applicability of these products and their effectiveness and incurred liability in using these products.



# **IMPORTANT**



## **VENT STOPPER PLUGS for CONDUIT**

Foam Conduit Feed Plugs for 1/2" I.D. Conduit Fittings



### **Conduit Feeds Must Be Sealed for Safe and Satisfactory Product Performance.**

Conduit Stopper Plugs prevent Humid Air exchange from venting thru external conduit into Dotworkz sealed enclosure, when conduit is used with Dotworkz enclosures. Vent Stopper Plugs eliminate Conduit driven condensation in surveillance camera enclosures, or other outdoor enclosure products.

#### **QUICK INSTALLATION GUIDE**



1) Pull wires to final installed length.



2) Open Vent Stop Plug and install over wire.



3) Pinch Plug to compress over wire, and insert into conduit feed mouth.



4) Push plug into conduit mouth with finger tips till it flush with outside of fitting.



5) Repeat steps 1-4 for any other conduit feeds as needed.



6) To assure an airtight seal, caulk around wires and cables, coating entire plug surface with sealant.



# D2 Exploded Detail

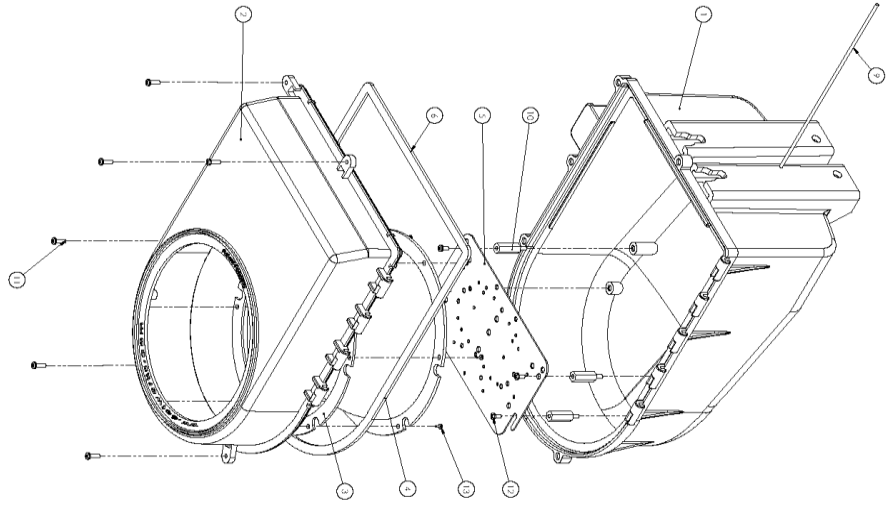
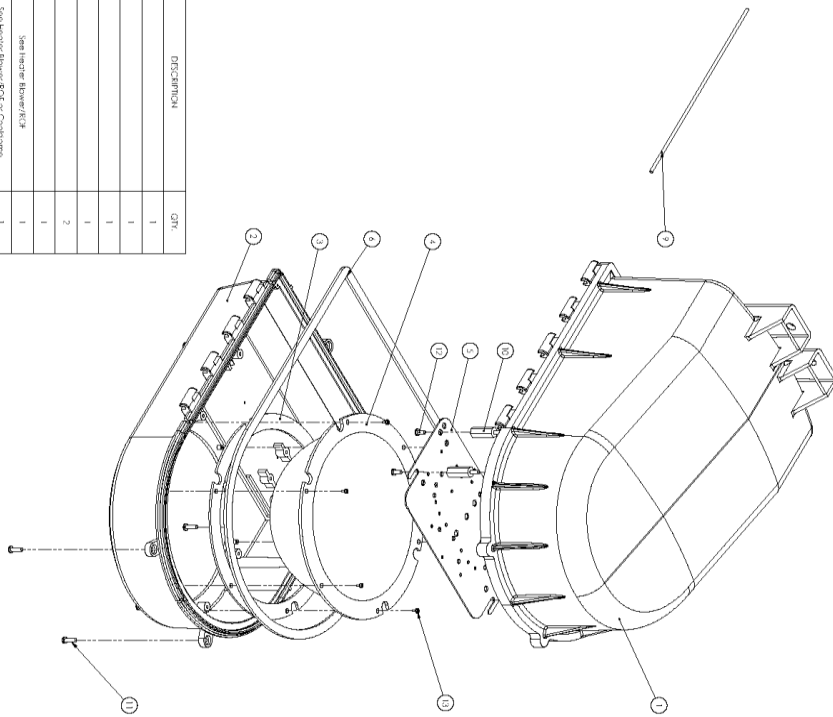

FIG. NO.	PART NUMBER	DESCRIPTION	QTY
1	Top Dome		1
2	Top Lens Glass		1
3	Top Cover		1
4	Lens		1
5	Top Frame D2		2
6	Key Holder		1
7	Crystals	See Note 1 below/1/2	1
8	Crystals Mt	See Note 1 below/1/2 or Consigne	1
9	Ringpart		1
10	1" cordant	QTY May vary depending on Camera	4
11	1032 Caprivs Screw 350		6
12	8.32 x 1.0 Phillips Head Machine Screw 350		4
13	8.32 x 1.0 x 1.5 Phillips Flat Head 350		6



1032 Caprivs Screw 350  
 8.32 x 1.0 Phillips Head Machine Screw 350  
 8.32 x 1.0 x 1.5 Phillips Flat Head 350  
 1" cordant  
 Ringpart  
 Crystals Mt  
 Crystals  
 Key Holder  
 Top Frame D2  
 Lens  
 Top Cover  
 Top Lens Glass  
 Top Dome

D2 Exploded BOM  
 DATE: 12/11/11  
 BY: [Name]  
 CHECKED BY: [Name]  
 APPROVED BY: [Name]



### D2 Mounting Detail

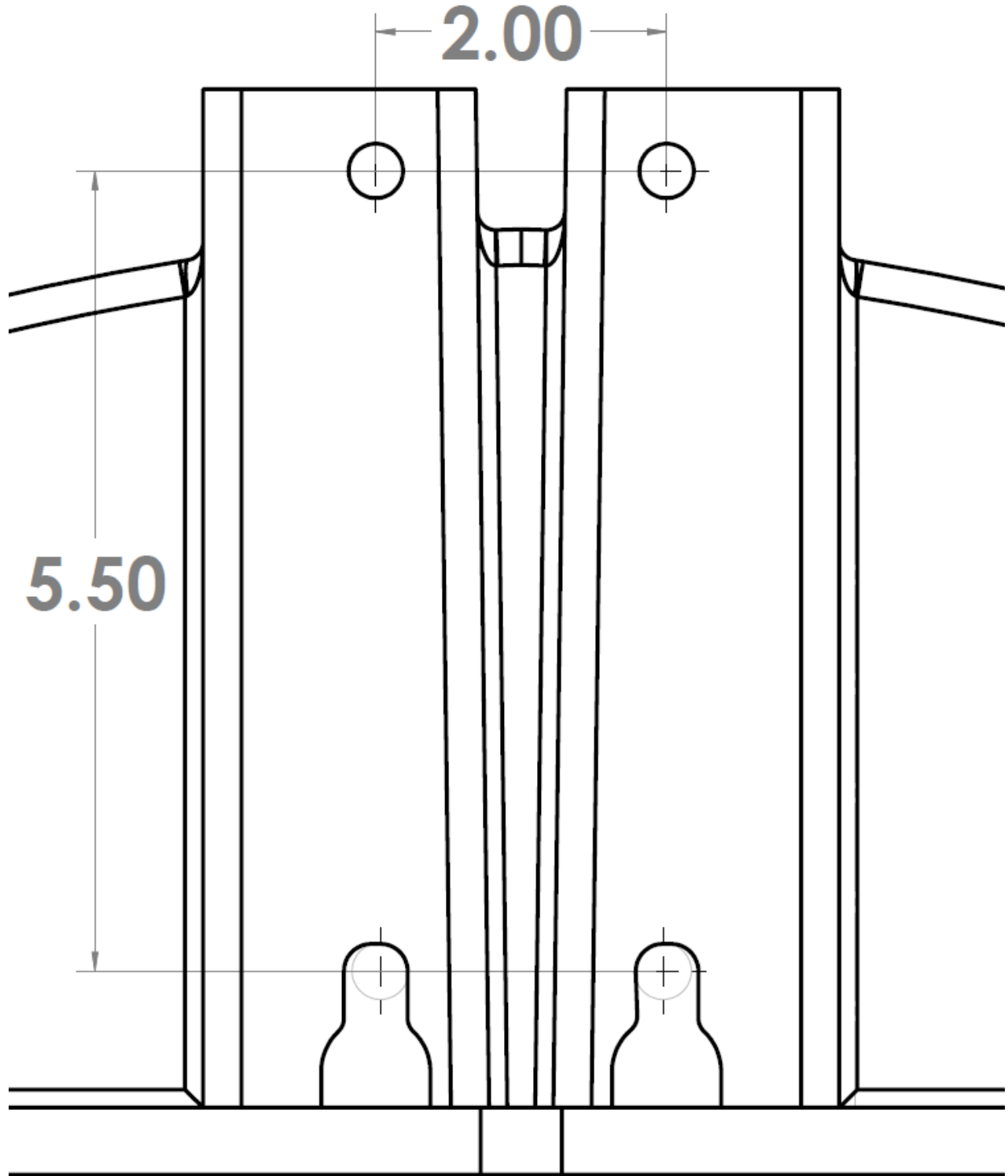

**3/8" Dia. Bolt Clearance Holes/ Key slots (4)**  
**All dimension in inches**